

Group 103

# Multiline 7

**Sürme Kapak Sistemi**

Sliding Door System



Bu serideki tüm ürünleri incelemek için QR kodu okutabilirsiniz.

You can search the QR code to see all the products in these series.

# Multiline 7

60 KG SÜRME KAPAK SİSTEMİ • SLIDING DOOR SYSTEM

Yeni Ürün  
New Product

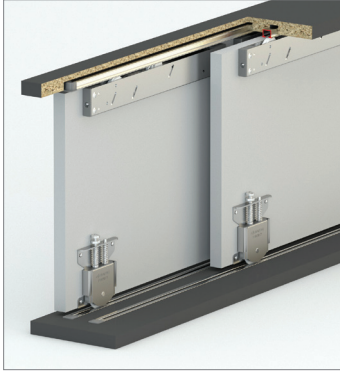

## Bilgi / Information

- 1 Kutu İçeriği : 2 Kapak Yavaşlatıcı Mekanizma
- In 1 box : 2 Door Mechanism with Soft Closers

## Yavaşlatıcı Alternatifi / Soft Closer Alternative

- Sistem üzerinde entegre yavaşlatıcı mevcuttur.
- The system has integrated soft closer.



## Multiline 7 1 Set İçeriği / 1 Set Includes

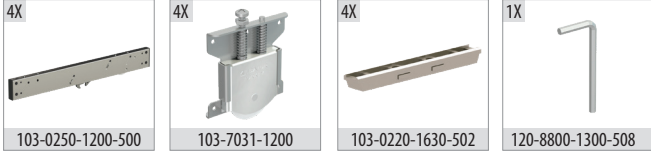

## Ray Profilleri / Rail Profiles

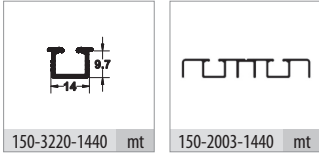

## Kulp Profilleri / Handle Profiles

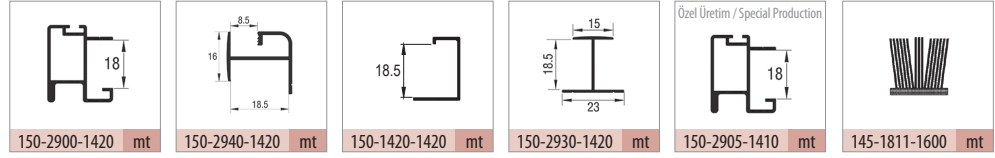

## Teknik Detay / Technical Detail

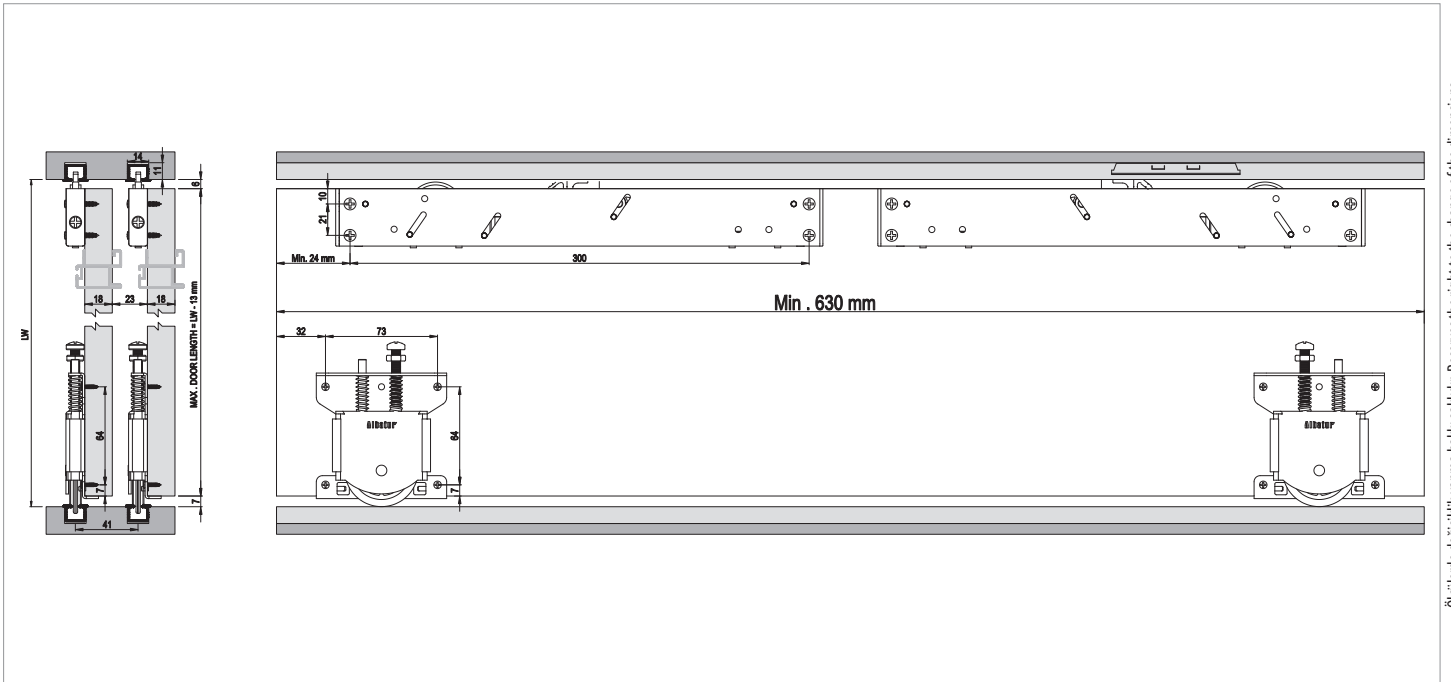

Ölçülerde değişiklik yapma hakkı saklıdır. Reserves the right to the change of the dimensions.

| Kod / Code No | Açıklama / Description  | Renk / Colour                | Birim / Unit    |     |       | Profil mt. / Profiles mt. | Bağ / Lap |
|---------------|---|------------------------------|-----------------|-----|-------|---------------------------|-----------|
| 103-0250-1200 | Multiline 7 - Sürme Gardrop Sistemi / Sliding Wardrobe System | Silver                       | 2 Kapak / 1 Set | 12  | 360   | - - -                     | -         |
| 145-1811-1600 | Kıl Fital / Ec-Wf Hair Wick                                   | Gri / Grey                   | mt.             | 300 | 7.200 | - - -                     | -         |
| 150-3220-1440 | Alüminyum Üst Ray Profili / Aluminium Upper Rail Profile      | Bronz Parlak / Bronze Bright | mt.             | -   | -     | - - 3,0                   | 6 ad/pcs  |
| 150-2003-1440 | Alüminyum Alt Ray Profili / Aluminium Bottom Rail Profile     | Bronz Parlak / Bronze Bright | mt.             | -   | -     | - - 3,0                   | 6 ad/pcs  |
| 150-2900-1420 | Alüminyum Kulp Profili / Aluminium Handle Profile             | Parlak / Bright              | mt.             | -   | -     | 2,0 2,5 3,0               | 6 ad/pcs  |
| 150-2905-1410 | Alüminyum Kulp Profili / Aluminium Handle Profile             | Eloksal / Mat Anodized       | mt.             | -   | -     | - - 3,0                   | 6 ad/pcs  |
| 150-2940-1420 | Alüminyum Orta Kayıt / Aluminium Horizontal Central           | Parlak / Bright              | mt.             | -   | -     | - - 3,0                   | 10 ad/pcs |
| 150-1420-1420 | Alüminyum Kapama Profili / Aluminium Closing Profile          | Parlak / Bright              | mt.             | -   | -     | - - 3,0                   | 10 ad/pcs |
| 150-2930-1420 | Alüminyum Orta Kayıt / Aluminium Horizontal Central           | Parlak / Bright              | mt.             | -   | -     | - - 3,0                   | 10 ad/pcs |

# Multiline 7

60 KG SÜRME KAPAK SİSTEMİ • SLIDING DOOR SYSTEM

Yeni Ürün  
New Product

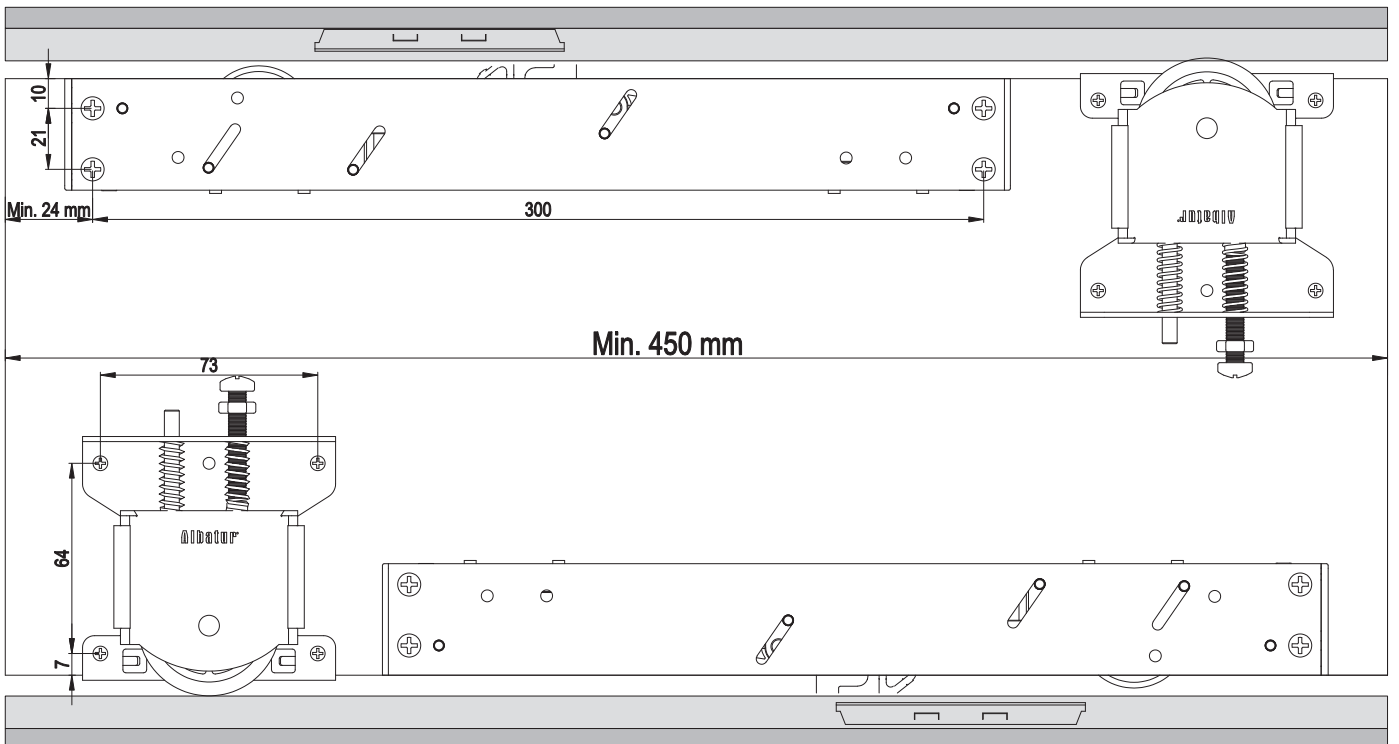
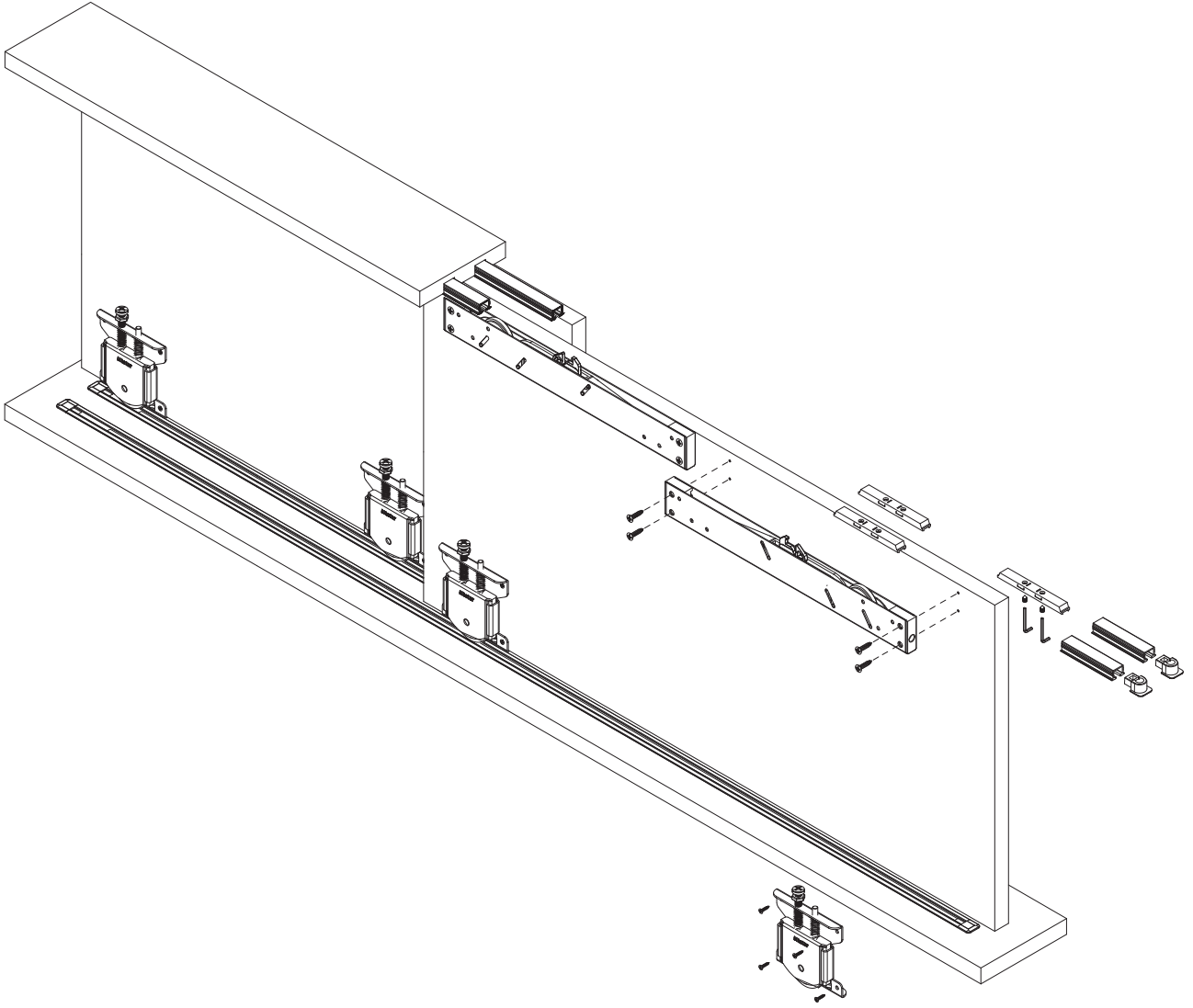

Ölçülerde değişiklik yapma hakkı saklıdır. Reserves the right to the change of the dimensions.

# Multiline 7

60 KG SÜRME KAPAK SİSTEMİ • SLIDING DOOR SYSTEM

Yeni Ürün  
New Product

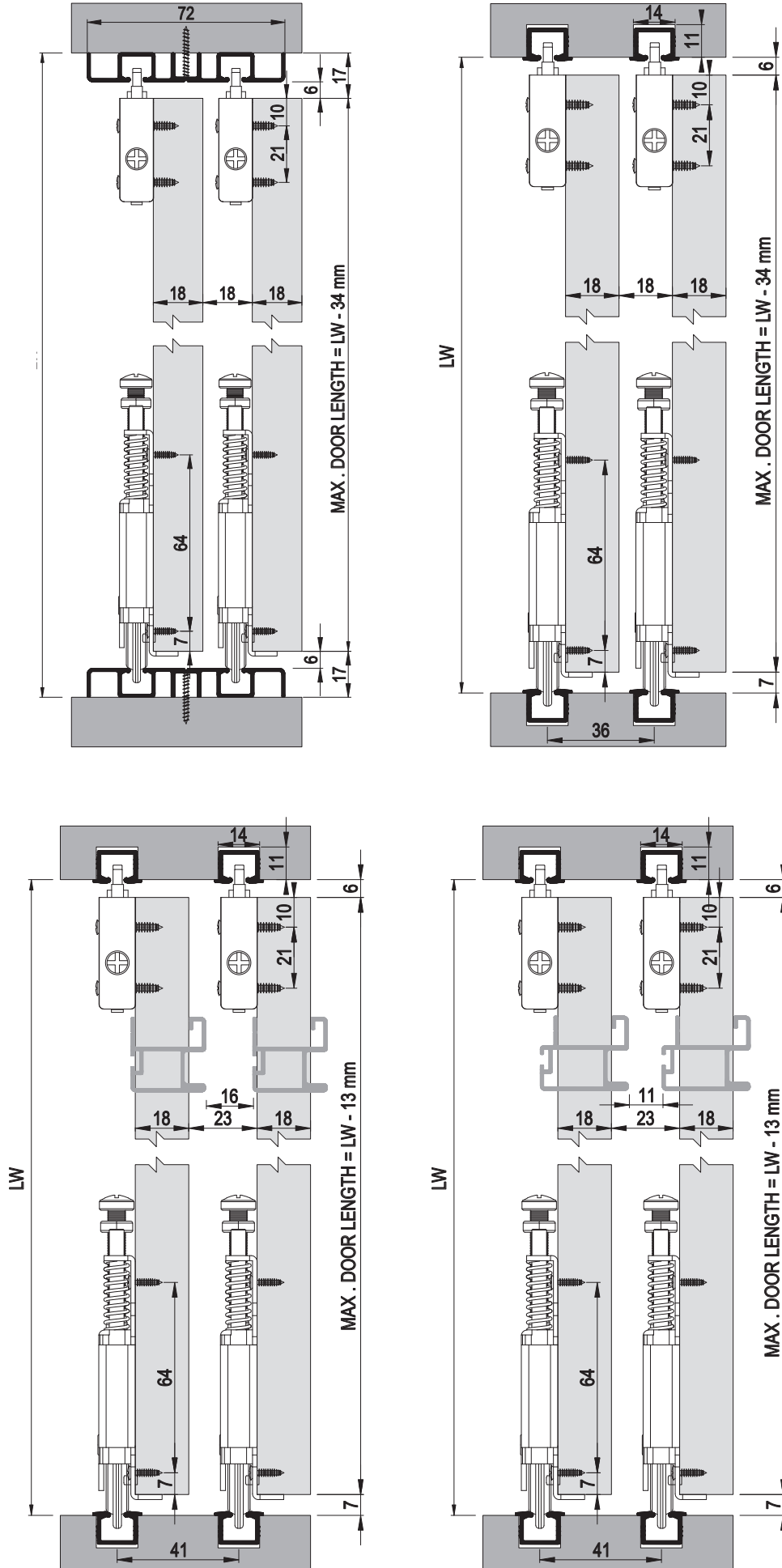

Ölçülerde değişiklik yapma hakkı saklıdır. Reserves the right to the change of the dimensions.



## ■ Multiline 7 1 Set İçeriği / 1 Set Includes

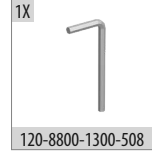
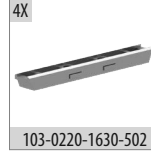
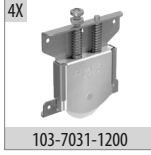
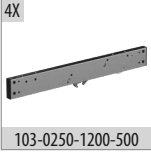

## ■ Ray Profilleri / Rail Profiles

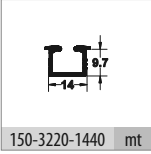

## ■ Kulp Profilleri / Handle Profiles

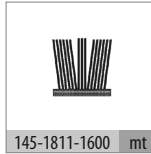
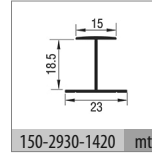
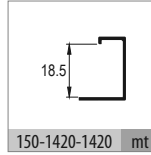
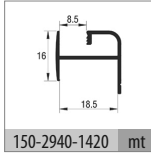
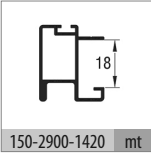

### ■ Ürün Özellikleri

- İçte çalışan alt taşıyıcı sürme dolap sistemidir.
- Ahşap kapaklarda uygulanabilir.
- Taşıma Kapasitesi 1 kapak için 60 kg'dır.
- 16 - 30 mm kapak kalınlıklarında kullanıma uygundur.
- Ray içi fren sistemi ile açılış ve kapanış yönünde frenleme özelliğine sahiptir.
- 2 / 3 / 4 kapaklı uygulamalar yapılabilir.
- Yükseklik ayarlı alt mekanizmaya sahiptir.
- Yüksek kaliteli rulman sayesinde sessiz ve uzun ömürlü çalışma sağlar.
- Kolay ve pratik montaj imkanı sunar.
- Multiline 7, tek gövde içerisinde entegre mekanizma ve yavaşlatıcı sistemine sahiptir.
- Ofis ve dolap sistemleri için tercih edilebilir.
- Gömme alt üst ray profili tercihinin yanı sıra farklı ray profil alternatiflerine sahiptir.
- Sessiz çalışması ve yavaşlatıcı sistemi sayesinde yüksek kaliteli bir kullanıcı deneyimi sağlar.
- Sürgü Sistemin 3D kurulum montaj videosuna [albaturas.com](http://albaturas.com)'dan ulaşabilirsiniz.

### ■ Product Properties

- It is a sliding cabinet system with inner working sub-carrier.
- Applicable on wooden covers.
- Carrying Capacity is 60 Kg for 1 cap.
- Suitable for use in 16 - 30 mm cover thicknesses.
- It has a braking feature in the opening and closing direction with its in-rail braking system.
- 2 / 3 / 4 cover applications can be made.
- It has a height-adjustable bottom mechanism.
- Provides quiet and long-lasting operation thanks to high-quality bearing.
- Provides easy and practical assembly.
- Multiline 7 has an integrated mechanism and retarder system in a single body.
- Can be preferred for office and cabinet systems.
- It has different rail profile alternatives as well as the choice of recessed lower and upper rail profile.
- It provides a high quality user experience thanks to its silent operation and deceleration system.
- You can reach the 3D installation video of the Sliding System at [albaturas.com](http://albaturas.com)

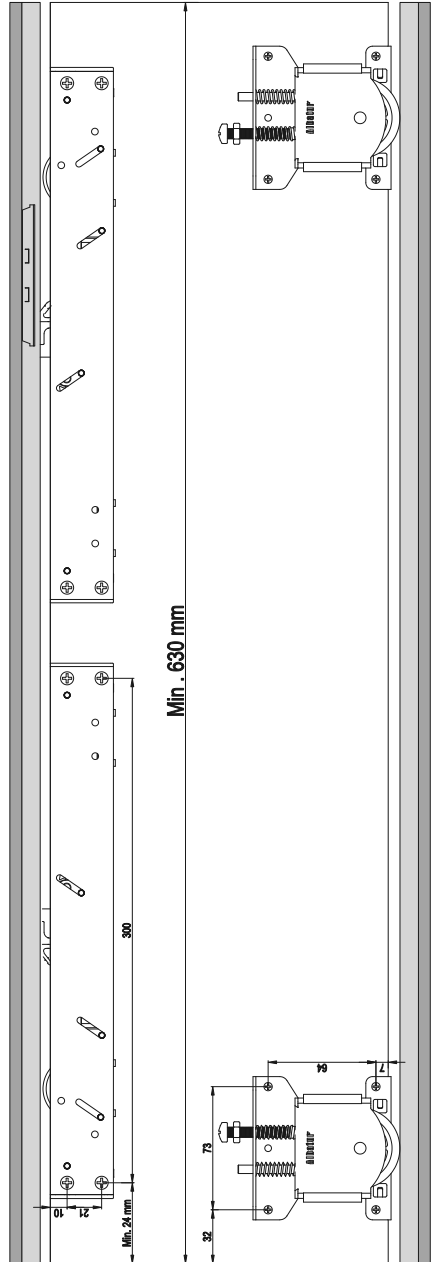
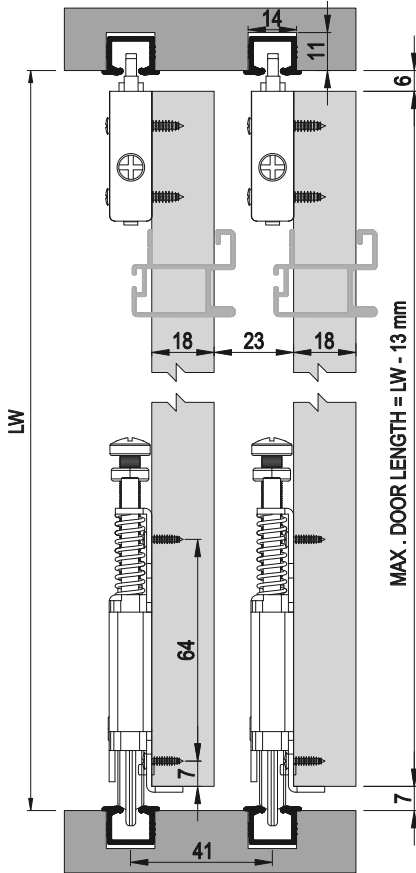

Öçülerde değişiklik yapma hakkı saklıdır. Reserves the right to the change of the dimensions.

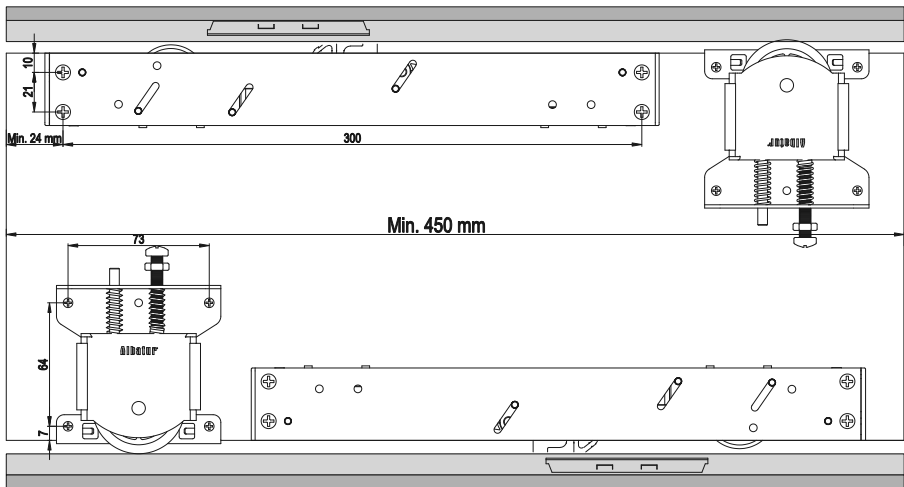
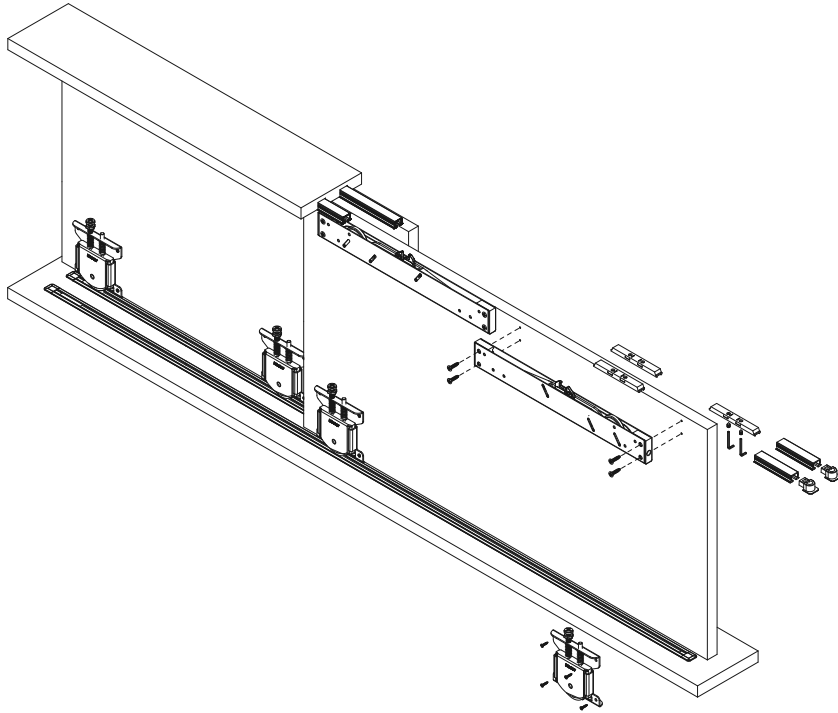

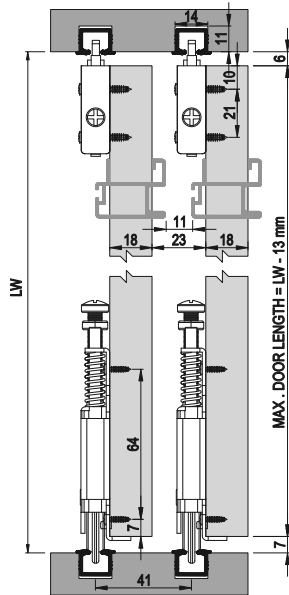
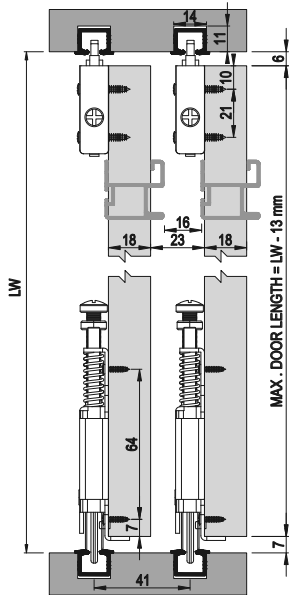
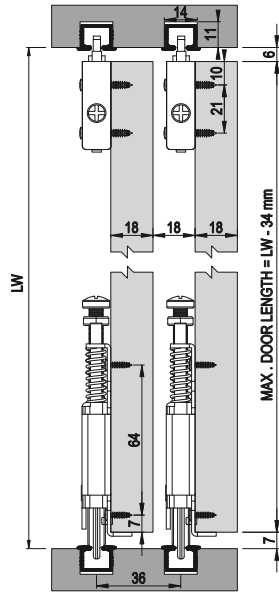
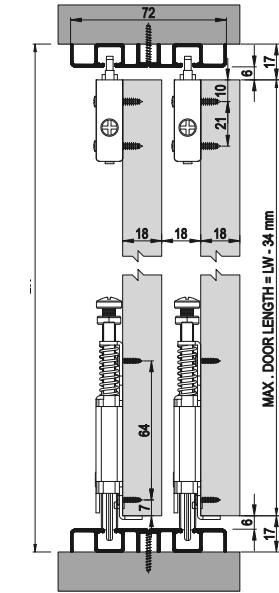

Ölçülerde değişikliklik yapma hakkına sahiptir. Reserves the right to the change of the dimensions.